

This product is intended for installation only by expert users. Please consult with a qualified technician for installation. Improper installation may result in damage to your equipment.

1. Please carefully read the manual before beginning the installation process !
2. It is strongly recommended to use market proven pre-mix coolant, such as Thermaltake Coolant.
3. DO NOT USE any kind of alcohol or alcohol derivatives with this reservoir or the acrylic tube may crack and fail ! Do not clean it using alcohol either !

Before Installation

Cautions: Make sure there's enough space when you start set up the LCS product

Radiators

To ensure a clean loop, flush and rinse your radiators and water blocks with distilled water before using.

Make sure the fittings are screwed securely when placing them onto the radiator.

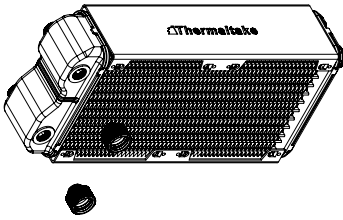

Case Fan

Attach the fans to the radiator

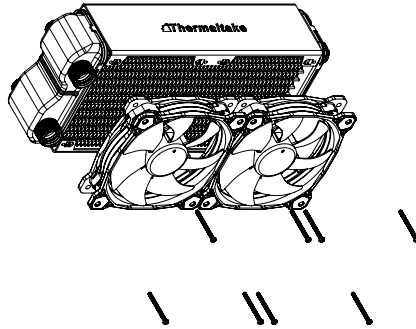

Water Blocks

Attach the fittings to the inlet and outlet of the waterblock.

Attach the waterblock onto the motherboard by referring to the enclosed manual.

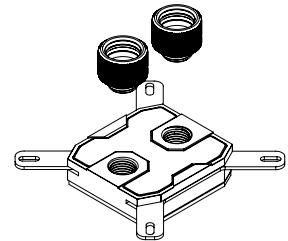

Pump and Reservoir

Choose the proper way to mount the pump and reservoir by referring to the manual (suggest vertical placement)

Attach fittings onto the pump and reservoir

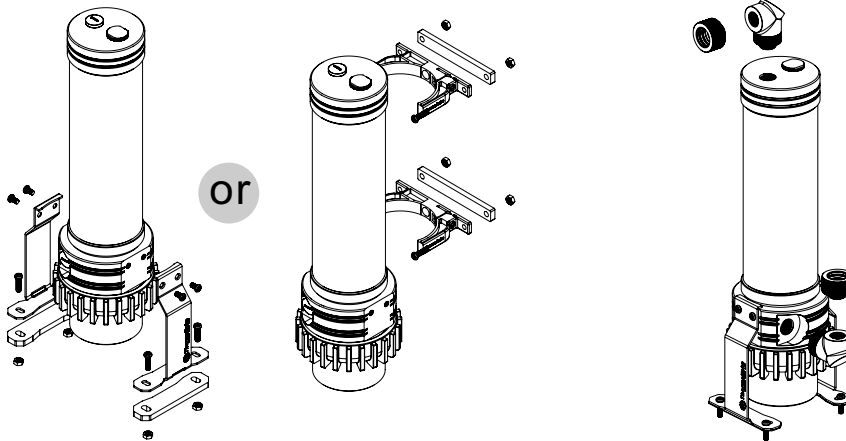

Installation Walkthrough (Example: Core V51)

1 Place the motherboard into the case.

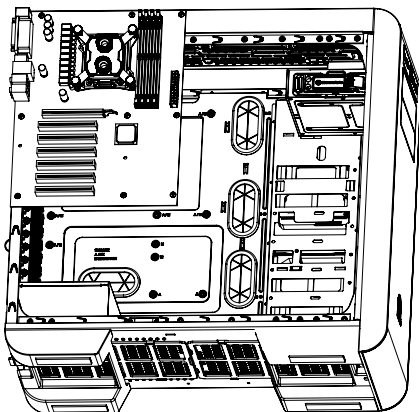

2 Position the radiator.

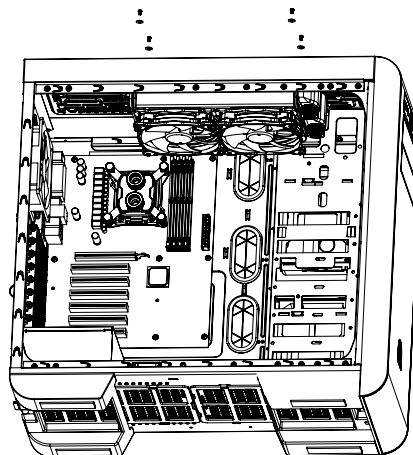

3 Attach the pump and reservoir into the chosen locations.

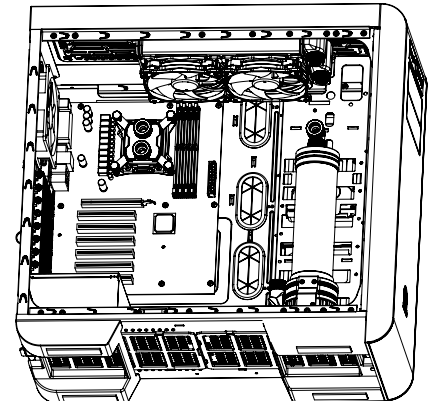

Cutting and Attaching the Tubing

- 1** Push the end of the tubing over the fitting ; make sure the tubing is a tight fit. Slide the cap over the fitting and rotate it clockwise until the tubing is sealed in place.

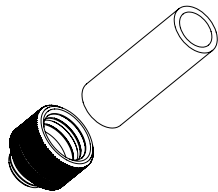

- 4** Connect the tubing and check all the fittings are sealed. The loop order: Radiator > Reservoir Inlet

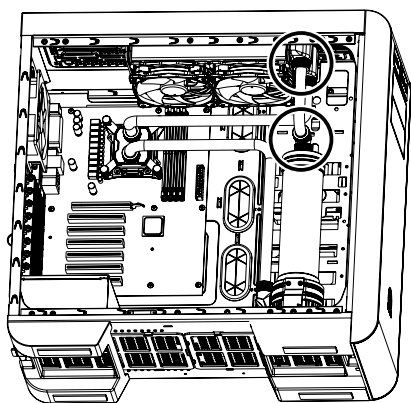

- 2** Connect the tubing and check all the fittings are sealed. The loop order: Pump Outlet > Water Block

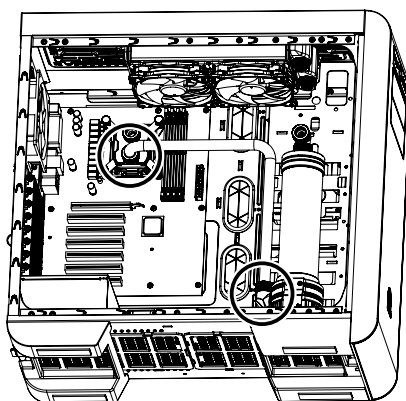

- 3** Connect the tubing and check all the fittings are sealed. The loop order: Water Block > Radiator

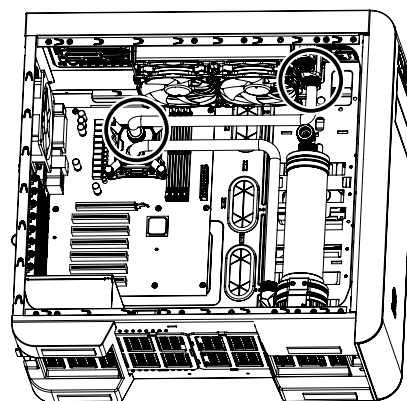

Filling the System

Cautions:

1. Before filling the system, please make sure that each fitting as well as unused ports are completely sealed.
2. If there is any case of leaking, immediately turn off the power and clean the leak
3. If there's any related electronic parts stained on liquid coolant, make sure to completely clean and dry the components. And then make sure they all work well.

- 1** After switching off the power supply, connect the PSU power cord and product cables.

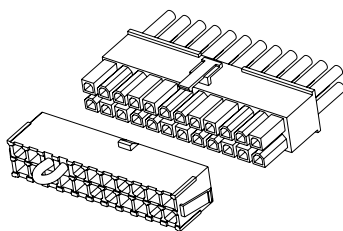

- 2** Use the refill bottle to fill coolant into the reservoir

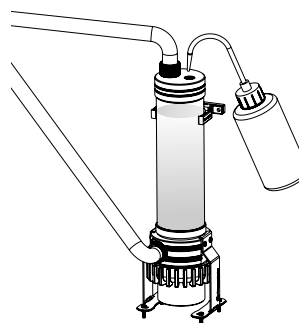

- 3** Place your PSU outside of the case and attach it to the pumps 4pin molex connector, turn on the power of PSU and make the rest of the system fills up.

Thermaltake recommends the following steps to be taken after completing your water loop setup

1. It is strongly recommended to use market proven pre-mix coolant, such as Thermaltake Coolant 1000. It offers great performance while preventing the entire cooling system – copper, brass, nickel, aluminum, and steel – from corrosion.
2. Fill the reservoir with coolant and cycle the power on and off several times while the pump pushing the coolant into the loop.
3. DO NOT let the pump run dry, when there is no liquid entering the pump turn off your power immediately
4. Fill the reservoir to the top as it will prevent air from going into the pump
5. If necessary tilt the system slightly from side to side to bleed the air out of the loop.
6. Place some paper towels under fittings and joining points to test for leaks.
7. Run the loop with the fill port open for about 24 hours to completely bleed the air out of the loop.